



# 2024 / 2025

2<sup>nd</sup> Edition



# Content



**21**  
Wall Fans



**24**  
Auto Fan



**26**  
Wall Mounted  
Ventilating Fans



**30**  
Ceiling Mounted  
Sirocco  
Ventilating Fans



**35**  
Industrial  
Ventilating Fan



**01**  
Ceiling Fans



**23**  
Commercial  
Wall Fans



**25**  
Glass Mounted  
Ventilating Fans



**29**  
Ceiling Mounted  
Ventilating Fans



**33**  
High Pressure  
Industrial  
Ventilating Fans



**36**  
Accessories

# Safety Features For Ceiling Fans



## Safety Wire

Safety Wire secures the fan motor to the ceiling hook.



## Cut-off Safety Switch

Cut off power supply while detecting dangerous wear and tear of the shaft or bolt.



## Blade Safety Hanger

(applicable to all regulator ceiling fans, K14XF, K14KF, K14TE, K14QF, K14XZ, K14YZ, K11Z1)

In the event of breakage of the blade frame, the Blade Safety Hanger will hold the blade to the motor.



## Blade Safety Hook

(applicable to K14Y2, K15Y2, K12UX, K15YX, K15UW, K14ZW, K15Z5, K12UC, K12Y2, K15YC, K15UC and K18NY)

In the event of breakage of the blade frame, the Blade Safety Hook will hold the blade to the motor.



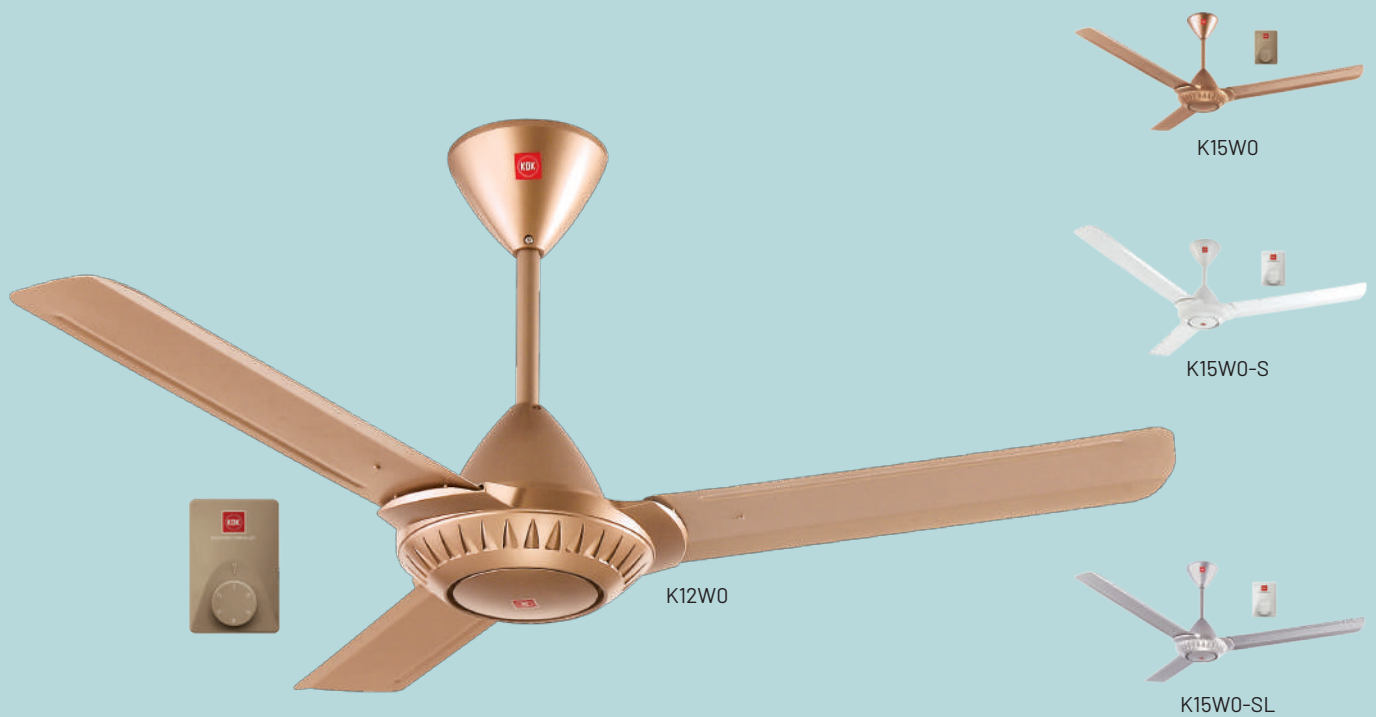

## Features



Treated with double hybrid coating treatment for added protection and reliability.

It is ideal for coastal areas, where the air is salty and corrosive.  
(Applicable to K15W0-S only)



Meets C.O.P (Co-Efficient of Performance) requirements



Energy saving condenser motor



Durable metal blades

## Dimensions

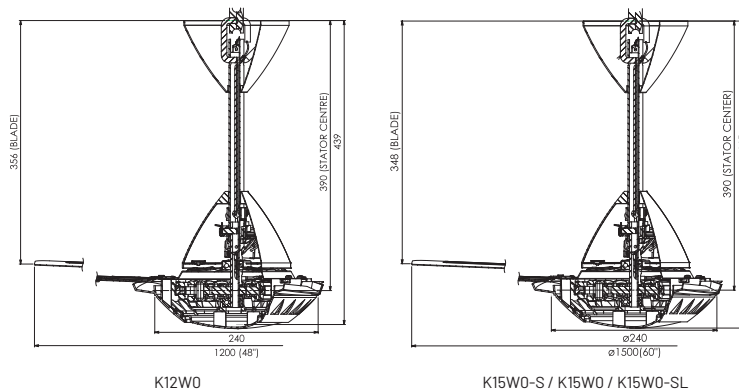

## Specifications

Model	Color	No. of Blade	Dimension	Energy Star Rating	RPM		CFM	Motor W		Motor HP	Motor Type	Noise Level (dB)	Nett Weight (kg)		
					Low	High		Low	High						
K12W0	Copper Brown	3	48"/120cm	5	131-177	273-333	5721	15.1-20.5	47.7-58.3	0.08	14 Pole Condenser	<58	4.80		
K15W0-S	White		60"/150cm		81-118	216-264		8122	14.7-19.9				67.5-82.5	0.10	5.50
K15W0	Copper Brown				<62	5.30									
K15W0-SL	Silver														

# Remote Control Ceiling Fans



## Alternating Current (AC) Motor

- K11ZF
- K14XF
- K14YZ
- K15Y2
- K14KF
- K14XZ
- K14Y2



## Direct Current (DC) Motor

- K14TE
- K12UX
- K14ZW
- K12UC
- K15UC
- K15YX
- K14QF
- K15UW
- K15Z5
- K12YC
- K15YC
- K18NY



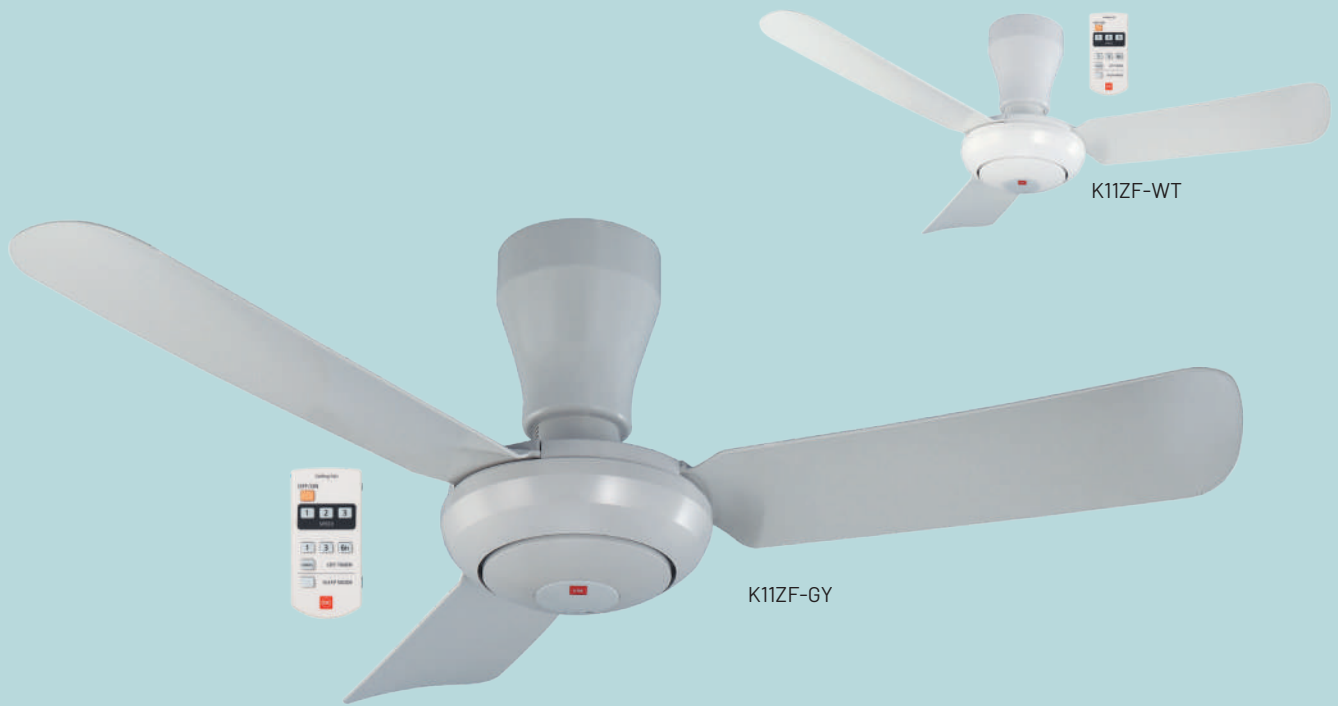

## Features



Hook structure installation



Remote control with 3 preset speed, 1, 3, 6 hours OFF timer and sleep mode



PPG material blades for better durability and anti rust

## Dimensions

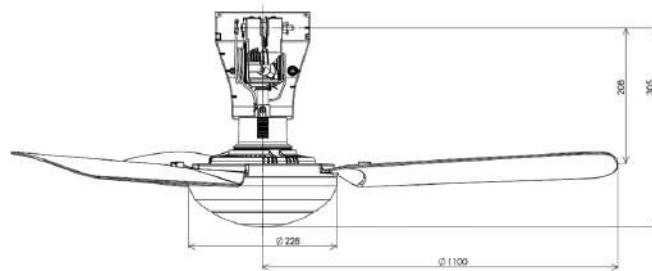

K11ZF

## Specifications

Model	Color	No. of Blade	Dimension	Energy Star Rating	RPM		CFM	Motor W		Motor HP	Motor Type	Noise Level (dB)	Nett Weight (kg)
					Low	High		Low	High				
K11ZF-WT	White	3	44"/110cm	4	133	239	6003	20	58	0.077	AC	49.5	5.20
K11ZF-GY	Grey												



## Features



Canopy Short Pipe design for low ceiling room



Remote control with 3 preset speed, 1, 3, 6 hours OFF timer and sleep mode



Durable metal blades

## Dimensions

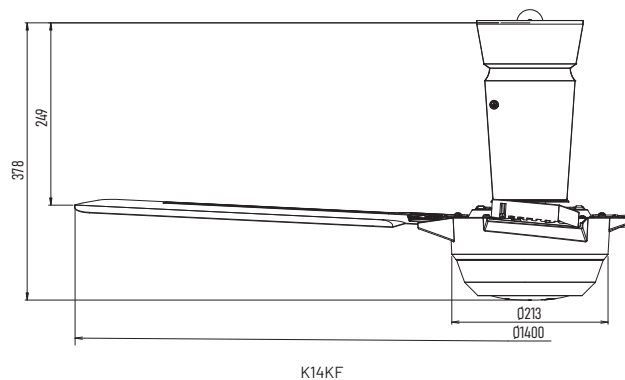

## Specifications

Model	Color	No. of Blade	Dimension	Energy Star Rating	RPM		CFM	Motor W		Motor HP	Motor Type	Noise Level (dB)	Nett Weight (kg)
					Low	High		Low	High				
K14KF-BK	Black	3	56"/140cm	5	136	268	7416	20	65	0.09	AC	56	5.20
K14KF-GY	Grey												





## Features



Remote control with 3 preset speed, 1, 3, 6 hours OFF timer and sleep mode



Durable metal blades



Optional extended fan rod (refer page 36)

## Dimensions

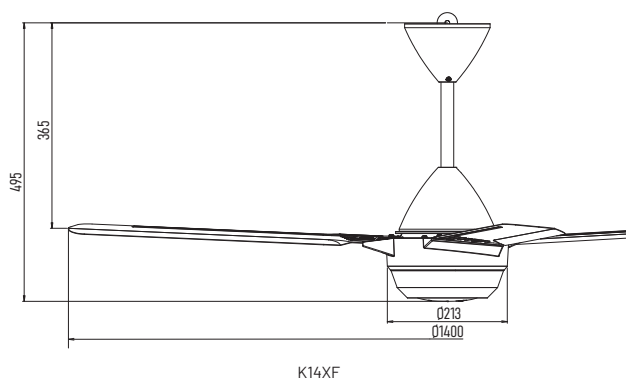

## Specifications

Model	Color	No. of Blade	Dimension	Energy Star Rating	RPM		CFM	Motor W		Motor HP	Motor Type	Noise Level (dB)	Nett Weight (kg)
					Low	High		Low	High				
K14XF-GY	Grey	3	56"/140cm	5	136	268	7416	20	65	0.09	AC	56	5.20
K14XF-BK	Black												



## Features



Remote control with 3 preset speed, 1, 3, 6 hours OFF timer and sleep mode



Strong and smooth air breeze in silent operation



Innovative design with two colours option



Durable metal blades

## Dimensions

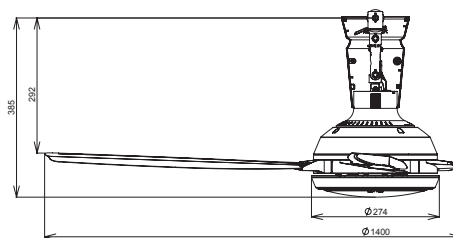

K14XZ

## Specifications

Model	Color	No. of Blade	Dimension	Energy Star Rating	RPM		CFM	Motor W		Motor HP	Motor Type	Noise Level (dB)	Nett Weight (kg)
					Low	High		Low	High				
K14XZ-GY	Grey	4	56"/140cm	5	102	196	7593	20	68	0.091	AC	51	7.00
K14XZ-PBR	Brown												



## Features



Remote control with 3 preset speed, 1, 3, 6 hours OFF timer and sleep mode



Strong and smooth air breeze in silent operation



Innovative design with two colours option



Durable metal blades

## Dimensions

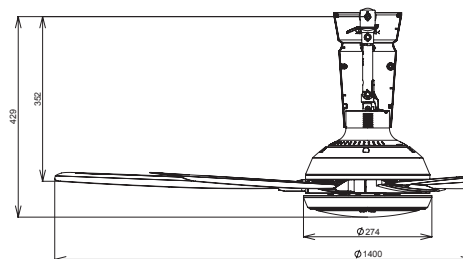

K14YZ

## Specifications

Model	Color	No. of Blade	Dimension	Energy Star Rating	RPM		CFM	Motor W		Motor HP	Motor Type	Noise Level (dB)	Nett Weight (kg)
					Low	High		Low	High				
K14YZ-GY	Grey	5	56"/140cm	5	95	183	7593	21	69	0.092	AC	51	7.60
K14YZ-PBR	Brown												



K14Y2 (V-Touch® Jr.)

## Features



Remote control with 5 preset speed, 3-6 hours sleep mode and 1-6 hours OFF timer



Equipped with 1/f Yuragi feature (Natural Breeze)



3D Aero Curve blade design



Distinctive blade material (PPG) for better durability, rust and dent resistance



Modern deco design with Japan Film Injection Technology

## Dimensions

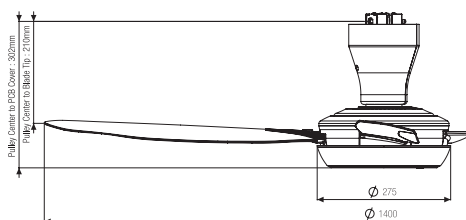

K14Y2

## Specifications

Model	Color	No. of Blade	Dimension	Energy Star Rating	RPM		CFM	Motor W		Motor HP	Motor Type	Noise Level (dB)	Nett Weight (kg)
					Low	High		Low	High				
<b>K14Y2</b>	Silver Grey	3	56"/140cm	2	102	215	7946	17.8	85	0.11	AC	52	6.40



## Features



Remote control with 5 preset speed, 3-6 hours sleep mode and 1-6 hours OFF timer



Equipped with 1/f Yuragi feature (Natural Breeze)



3D Aero Curve blade design



Distinctive blade material (PPG) for better durability, rust and dent resistance



Modern deco design with Japan Film Injection Technology

## Dimensions

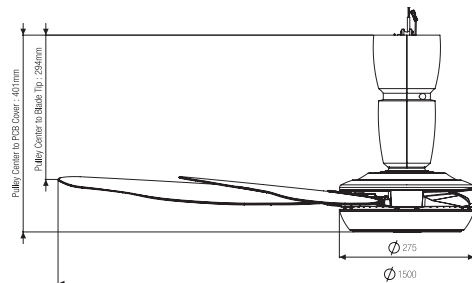

K15Y2

## Specifications

Model	Color	No. of Blade	Dimension	Energy Star Rating	RPM		CFM	Motor W		Motor HP	Motor Type	Noise Level (dB)	Nett Weight (kg)
					Low	High		Low	High				
<b>K15Y2-CO</b>	Copper Bronze	4	60"/150cm	2	84	195	7946	20.5	85	0.11	AC	48	7.40
<b>K15Y2-GS</b>	Silver Grey												



## Features



Remote control with 5 preset speed, 3-6 hours sleep mode and 1-6 hours OFF timer



Geared up with 1/f Yuragi feature (Natural Breeze)



Sleek design with two colours option



Durable metal blades



DC (Direct Current) motor for energy saving



Optional extended fan rod (refer page 36)

## Dimensions

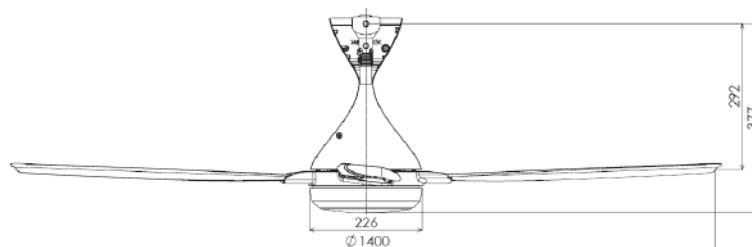

K14TE

## Specifications

Model	Color	No. of Blade	Dimension	Energy Star Rating	RPM		CFM	Motor W		Motor HP	Motor Type	Noise Level (dB)	Nett Weight (kg)
					Low	High		Low	High				
K14TE-DG	Dark Grey	4	56"/140cm	5	80	200	7769	4	29	0.04	DC	54	5.10
K14TE-WT	White												

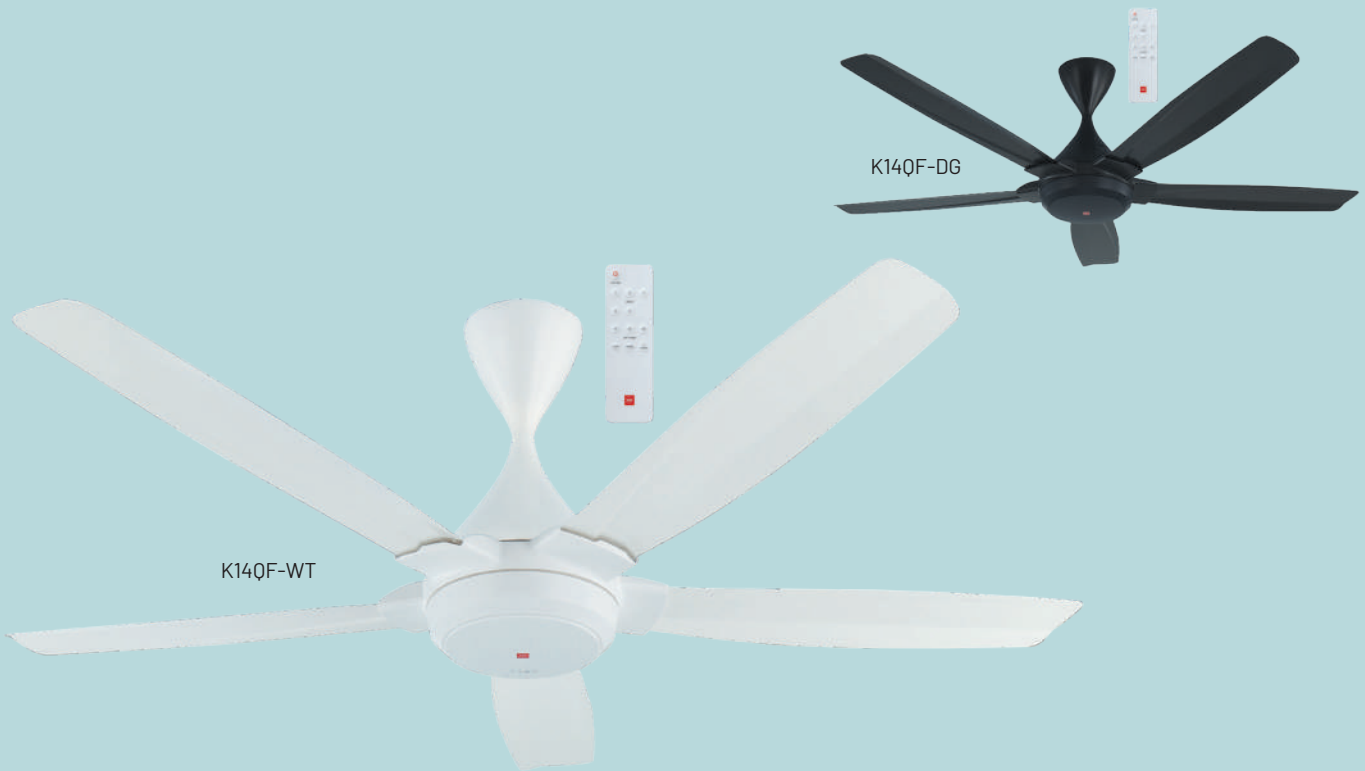

## Features



Remote control with 5 preset speed, 3-6 hours sleep mode and 1-6 hours OFF timer



Geared up with 1/f Yuragi feature (Natural Breeze)



Sleek design with two colours option



Durable metal blades



DC (Direct Current) motor for energy saving



Optional extended fan rod (refer page 36)

## Dimensions

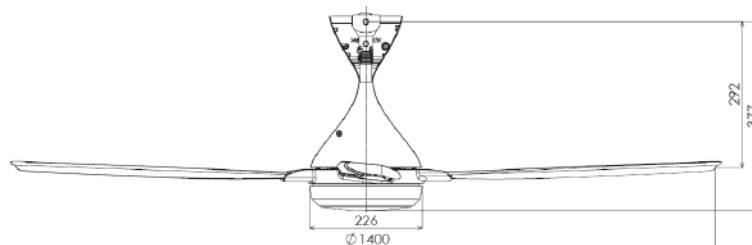

K140F

## Specifications

Model	Color	No. of Blade	Dimension	Energy Star Rating	RPM		CFM	Motor W		Motor HP	Motor Type	Noise Level (dB)	Nett Weight (kg)
					Low	High		Low	High				
K140F-DG	Dark Grey	5	56"/140cm	5	80	175	7769	4	29	0.04	DC	54	5.70
K140F-WT	White												



## Features



Remote control with 9 preset speed, 2-8 hours sleep mode, 1-8 hours OFF and ON timer



LED Lighting comes with 3 level of brightness control dedicated for different needs and preference



Distinctive blade material (PPG) for better durability, rust and dent resistance



DC (Direct Current) motor for energy saving



Geared up with 1/f Yuragi feature (Natural Breeze)



Built-in LCD screen remote control



Suitable for small and low ceiling room

## Dimensions

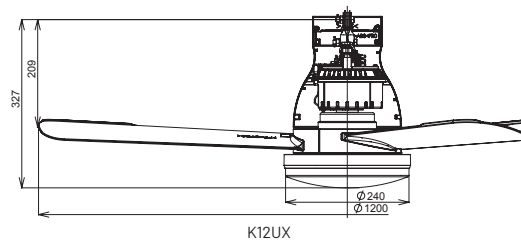

## Specifications

Model	Color	No. of Blade	Dimension	Energy Star Rating	RPM		CFM	Motor W				Motor HP	Motor Type	Noise Level (dB)	Nett Weight (kg)
					Low	High		Fan Only		Fan & Light					
								Low	High	Low	High				
K12UX	Elegant Grey	3	48"/120cm	5	80	236	6603	3.0	28.0	21.0	46.0	0.038	DC	50	4.90

Model	K12UX		
	High	Medium	Low
Brightness Control	150(lx)	75(lx)	3(lx)
LED Colour	Cool Daylight		
Wattage	18W	9W	1W



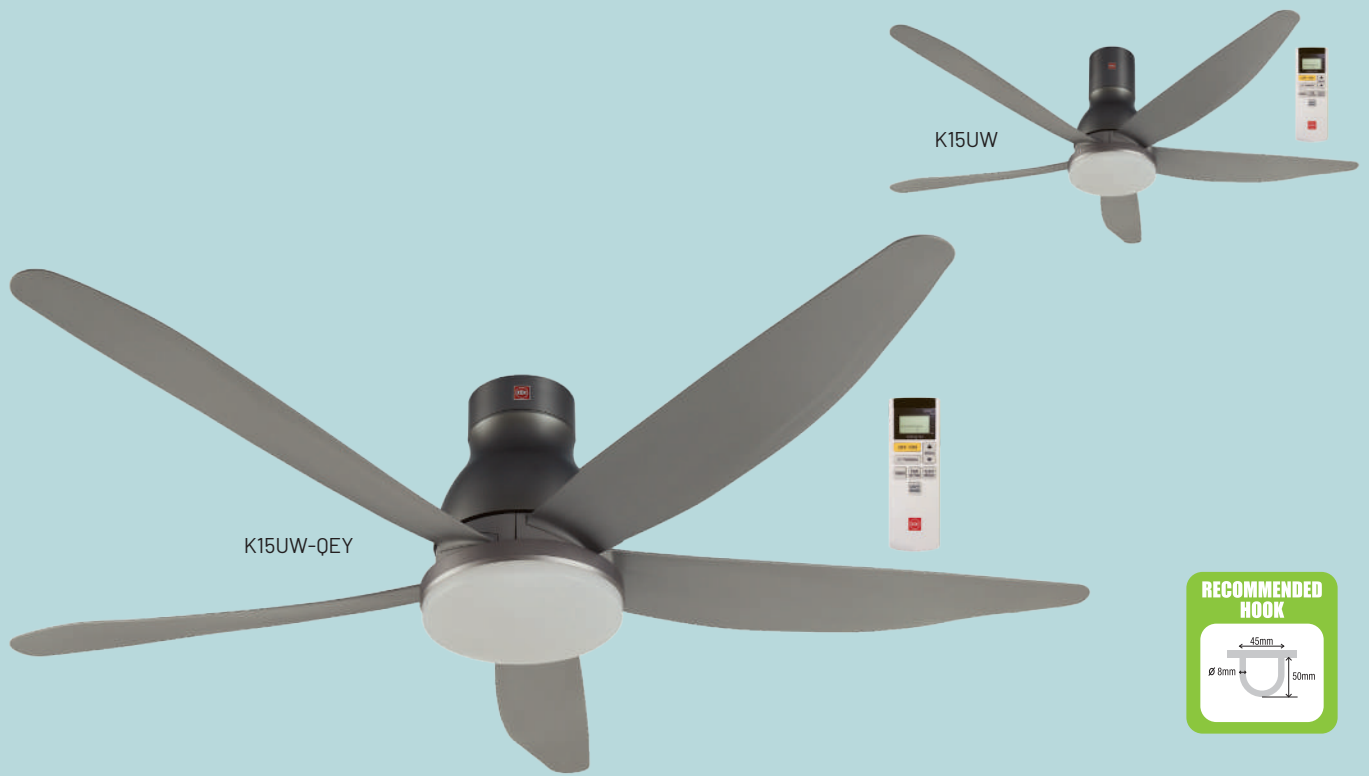

## Features



Remote control with 9 preset speed, 2-8 hours sleep mode, 1-8 hours OFF and ON timer



LED Lighting comes with 3 level of brightness control dedicated for different needs and preference



Modernistic design with short pipe or long pipe



DC (Direct Current) motor for energy saving



Geared up with 1/f Yuragi feature (Natural Breeze)



Built-in LCD screen remote control



Distinctive blade material (PPG)

## Dimensions

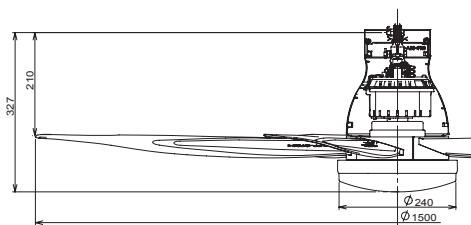

K15UW-QEY

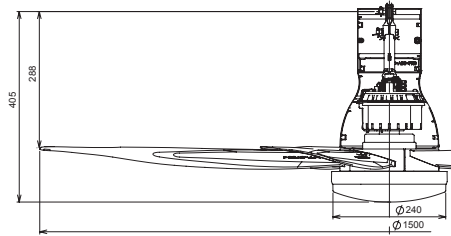

K15UW

## Specifications

Model	Color	No. of Blade	Dimension	Energy Star Rating	RPM		CFM	Motor W				Motor HP	Motor Type	Noise Level (dB)	Nett Weight (kg)
					Low	High		Fan Only		Fan & Light					
								Low	High	Low	High				
K15UW-QEY	Elegant Grey	5	60"/150cm	5	80	235	8652	3.0	41.0	25.0	63.0	0.055	DC	53	6.00
K15UW	Grey							6.20							

Model	K15UW-QEY / K15UW			
	High	Medium		Low
Brightness Control	200(lx)	150(lx)		3(lx)
LED Colour	White	Cool Daylight	Warm	Warm
Wattage	22W	18W	18W	1W

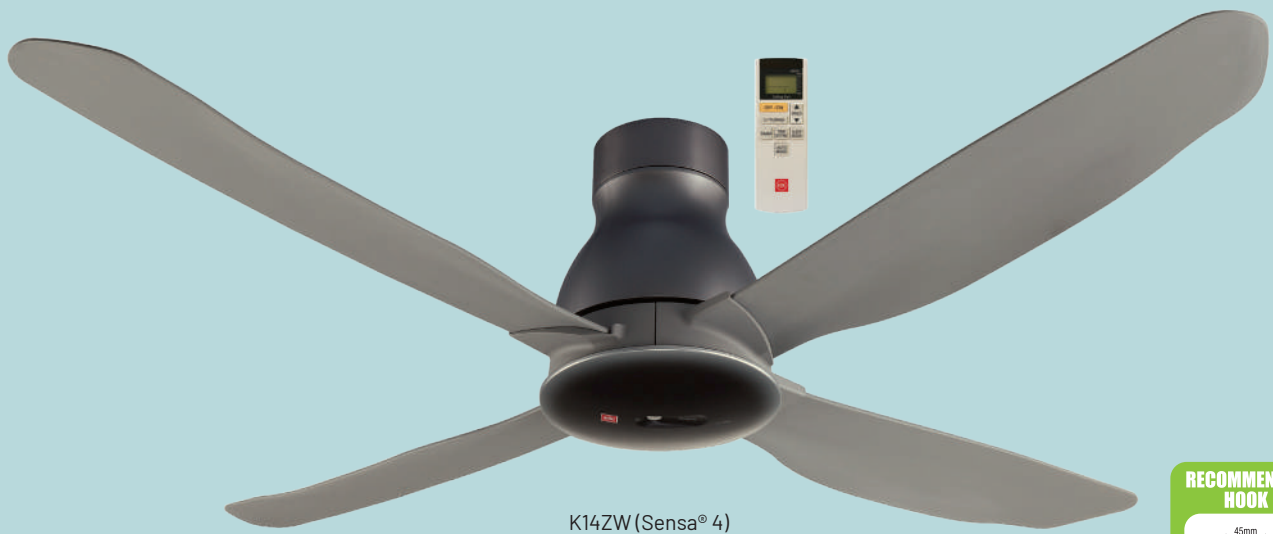

## Features



Remote control with 9 preset speed, 2-8 hours sleep mode, 1-8 hours OFF and ON timer



Geared up with 1/f Yuragi feature (Natural Breeze)



Temperature sensor equipped



Built-in LCD screen remote control



DC (Direct Current) motor for energy saving



Distinctive blade material (PPG)

## Dimensions

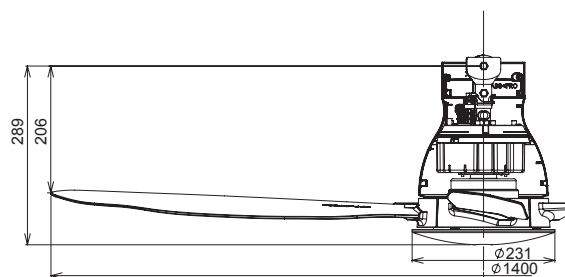

K14ZW

## Specifications

Model	Color	No. of Blade	Dimension	Energy Star Rating	RPM		CFM	Motor W		Motor HP	Motor Type	Noise Level (dB)	Nett Weight (kg)
					Low	High		Low	High				
<b>K14ZW</b>	Elegant Grey	4	56"/140cm	5	81	239	7946	2.5	41	0.055	DC	51	4.90

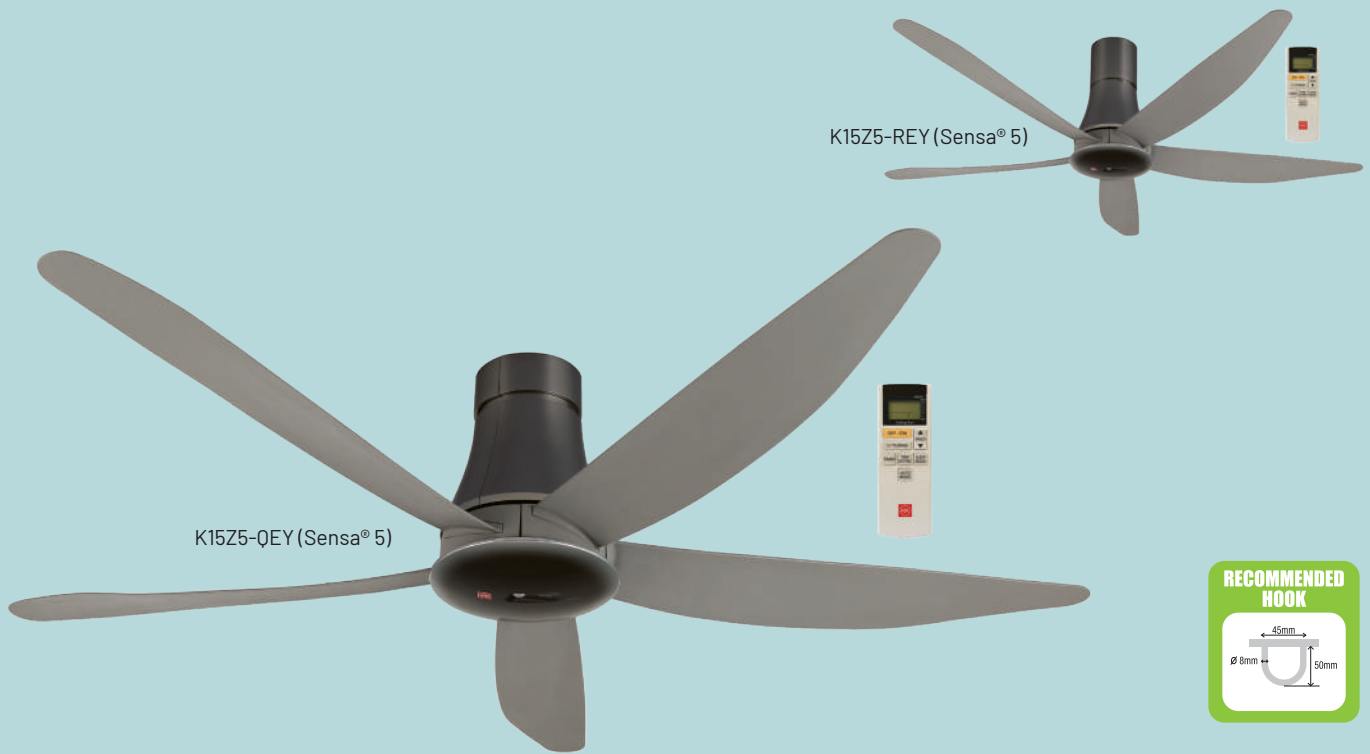

## Features



Remote control with 9 preset speed, 2-8 hours sleep mode, 1-8 hours OFF and ON timer



Geared up with 1/f Yuragi feature (Natural Breeze)



Temperature sensor equipped



DC (Direct Current) motor for energy saving



Modernistic design with short pipe or long pipe



Built-in LCD screen remote control



Distinctive blade material (PPG)

## Dimensions

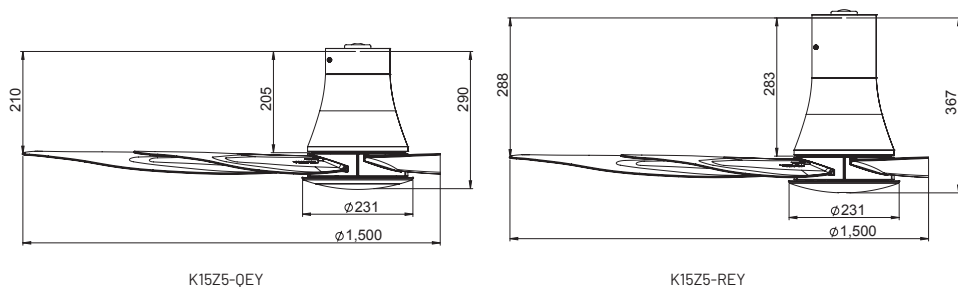

K15Z5-QEY

K15Z5-REY

## Specifications

Model	Color	No. of Blade	Dimension	Energy Star Rating	RPM		CFM	Motor W		Motor HP	Motor Type	Noise Level (dB)	Nett Weight (kg)
					Low	High		Low	High				
K15Z5-QEY	Elegant Grey	5	60"/150cm	5	80	235	8652	3	41	0.055	DC	54	5.10
K15Z5-REY													5.30



## Features

- Wi-Fi Smart control with 24 hours sleep mode, 24 hours ON/OFF timer and 1/f Yuragi (natural breeze) function
- Schedule function is set to perform preferred fan speed, ON/OFF timer and other features based on individual preference
- Reverse function drives the cool air upward and circulate the airflow evenly in comfortable temperature
- New Generation DC (direct current) motor for better air delivery and performance
- Stepless control of LED brightness and color (Applicable to K12UC only)
- Compatible Device: Android 6.0 or above and iOS 12.0 or above
- Distinctive blade material (ABS Glass Fibre) comfortable temperature
- Intelligent Motor Drive System (IMDS) for motor faulty detection
- Remote control with 10 preset speed
- Scene setting can be preset 4 light settings for daily activities (Applicable to K12UC only)

## Dimensions

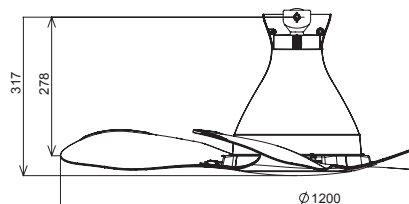

K12YC / K12UC

## Specifications

Model	Color	No. of Blade	Dimension	Energy Star Rating	RPM (Forward)		RPM (Reverse)		CFM	Motor W				Motor HP	Motor Type	Noise Level (dB)	Nett Weight (kg)
					Low	High	Low	High		Fan Only		Fan & Light					
										Low	High	Low	High				
K12YC	Matte Grey	3	48"/120cm	5	55	170	55	170	7063	3	31	-	-	0.042	DC	41	4.90
K12UC	Matte Grey	3	48"/120cm	5	55	170	55	170	7063	3	31	22	50	0.042	DC	41	5.20

Model	K12UC									
LED Color	Mix (White + Warm)		White		Warm		Night Light (Warm)			
Range	MIN	MAX	MIN	MAX	MIN	MAX	Low	Medium	High	
Brightness Control	23(lx)	200(lx)	26(lx)	150(lx)	26(lx)	150(lx)	0.15(lx)	0.6(lx)	1.1(lx)	
Wattage (LED Only)	1.9W	19W	2.1W	15W	2.1W	15W	0.2W	0.3W	0.4W	

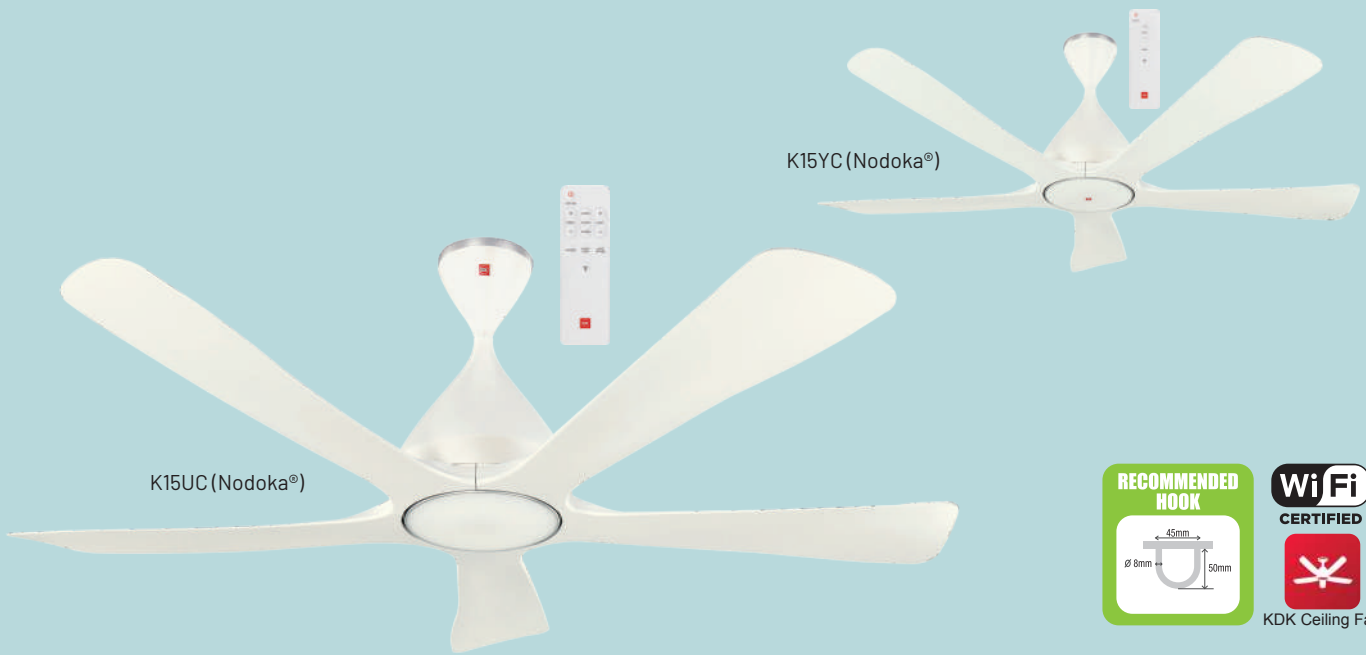

## Features

- Wi-Fi Smart control with 24 hours sleep mode, 24 hours ON/OFF timer and 1/f Yuragi (natural breeze) function
- Schedule function is set to perform preferred fan speed, ON/OFF timer and other features based on individual preference
- Reverse function drives the cool air upward and circulate the airflow evenly in comfortable temperature
- New Generation DC (direct current) motor for better air delivery and performance
- Stepless control of LED brightness and color (Applicable to K15UC only)
- Compatible Device: Android 6.0 or above and iOS 12.0 or above
- Distinctive blade material (ABS Glass Fibre)
- Intelligent Motor Drive System (IMDS) for motor faulty detection and blade faulty detection
- Remote control with 10 preset speed
- Scene setting can be preset 4 light settings for daily activities (Applicable to K15UC only)

## Dimensions

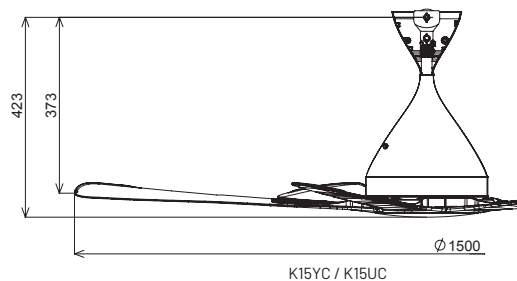

## Specifications

Model	Color	No. of Blade	Dimension	Energy Star Rating	RPM (Forward)		RPM (Reverse)		CFM	Motor W				Motor HP	Motor Type	Noise Level (dB)	Nett Weight (kg)
					Low	High	Low	High		Fan Only		Fan & Light					
										Low	High	Low	High				
K15YC	Pearl White	5	60"/150cm	5	80	245	80	255	10594	4	54	-	-	0.073	DC	59	7.00
K15UC	Pearl White	5	60"/150cm	5	80	245	80	255	10594	4	54	23	73	0.073	DC	59	7.30

Model	K15UC									
LED Color	Mix (White + Warm)		White		Warm		Night Light (Warm)			
Range	MIN	MAX	MIN	MAX	MIN	MAX	Low	Medium	High	
Brightness Control	23(lx)	200(lx)	26(lx)	150(lx)	26(lx)	150(lx)	0.15(lx)	0.6(lx)	1.1(lx)	
Wattage (LED Only)	1.9W	19W	2.1W	15W	2.1W	15W	0.2W	0.3W	0.4W	



## Features



Remote control with 9 preset speed, 2-8 hours sleep mode, 1-8 hours OFF and ON timer



Geared up with 1/f Yuragi feature (Natural Breeze)



DC (Direct Current) motor for energy saving



Distinctive blade material (PPG) for better durability, rust and dent resistance



Modernistic design with short pipe of long pipe



Built-in LCD screen remote control

## Dimensions

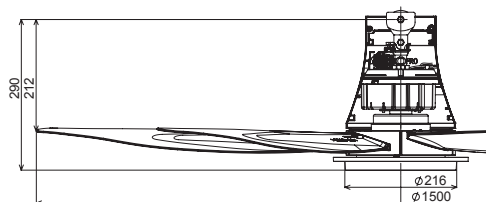

K15YX-QBR

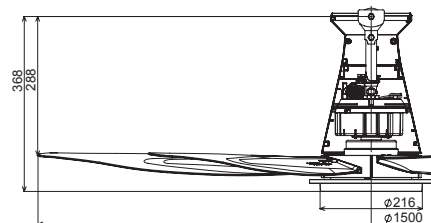

K15YX-RBR

## Specifications

Model	Color	No. of Blade	Dimension	Energy Star Rating	RPM		CFM	Motor W		Motor HP	Motor Type	Noise Level (dB)	Nett Weight (kg)
					Low	High		Low	High				
K15YX-QBR	Brown	5	60"/150cm	5	80	235	8652	3	41	0.055	DC	54	5.10
K15YX-RBR					5.30								



## Features



Remote control with 9 preset speed, 2-8 hours sleep mode, 1-8 hours OFF and ON timer



Twin DC (Direct Current) motor for energy saving



Optional extended fan rod (Applicable to K18NY-SBR only. Refer page 36)



Motion Sensor equipped



Geared up with 1/f Yuragi feature (Natural Breeze)



Preset fan speed memory function



Distinctive blade material (PPG)



Modernistic design with short pipe or long pipe



Ball-joint installation (no hook required)

## Dimensions

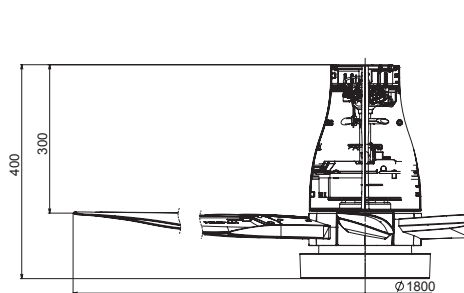

K18NY-RBR

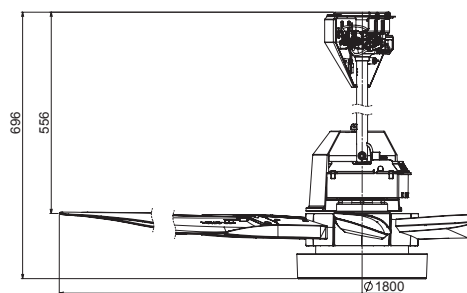

K18NY-SBR

## Specifications

Model	Color	No. of Blade	Dimension	RPM		CFM	Motor W		Motor HP	Motor Type	Noise Level (dB)	Nett Weight (kg)
				Low	High		Low	High				
K18NY-RBR	Dark Brown	6	70"/180cm	80	185	11477	6	55	0.074	DC	54	11.70
K18NY-SBR				11.90								







KC-4GR

## Features



Condenser motor with ball bearing



Full function remote control with ON/OFF timer, 3 speed control, timer setting and oscillation control



Manual ON/OFF and oscillation control available

## Specifications

Model	Color	Dimension	Energy Star Rating	RPM		CFM	Motor W		Motor HP	Motor Type	Noise Level (dB)	Nett Weight (kg)
				Low	High		Low	High				
<b>KC-4GR</b>	Black	16"/40cm	5	774-946	1103-1349	2225	43.0-52.7	53.4-65.2	0.09	14 Pole Condenser	<60	4.60



KU50Y



KU50Y-DG

\* Effective January 2025, this model code will be replaced with KU50G.

## Features



3 speed ON/OFF pull switch



Full automatic oscillation



Aluminium blade for stronger airflow and durability



Turbo Fin Guard design generates strong and focus airflow up to 10 meter distance



Front Guard Locking System for safety purpose



Added angle adjust bolt for extra stability on the fan's knee joint

## Specifications

Model	Color	Dimension	RPM		CFM	Motor W		Motor HP	Motor Type	Noise Level (dB)	Nett Weight (kg)
			Low	High		Low	High				
<b>KU50Y</b>	White	20"/50cm	940	1280	3885	60	70	0.094	14 Pole Condenser	59	6.00
<b>KU50Y-DG *</b>	Dark Grey										

\* Effective January 2025, this model code will be replaced with KU50G

## 24 Auto Fans



KQ409

## Features



360°  
oscillation



Easy adjustment angle  
15°, 30° and 50°



Condenser motor  
with ball bearing



5 speed  
electronic regulator

## Specifications

Model	Color	Dimension	Energy Star Rating	RPM		CFM	Motor W		Motor HP	Motor Type	Noise Level (dB)	Nett Weight (kg)
				Low	High		Low	High				
<b>KQ409</b>	White	16"/40cm	5	568-694	1089-1331	3002	18.3-22.4	46.8-57.2	0.08	14 Pole Condenser	<60	3.90

## 25 Glass Mounted Ventilating Fans



15WUD / 20WUD

### Features



Improved high performance condenser motor with long life bearing



Advanced blade design for high air volume and low noise level



Low power consumption



Strengthen Shutter Structure for better durability



Installed directly into the glass window (window panel thickness from 3mm-7mm)



Cord operated shutter

### Dimensions

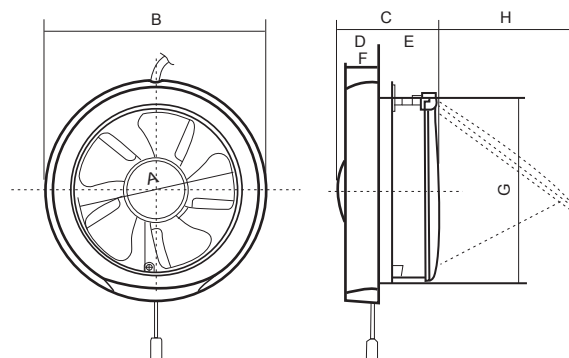

### Specifications

Model	Dimension	RPM	CFM	Motor Rating	Motor W	Motor Type	Noise Level (dB)	Nett Weight (kg)
15WUD	6"/15cm	1463	124	220-240V, 50Hz	8	Condenser	35	0.90
20WUD	8"/20cm	1042	212		16		32	1.10

### Dimension (mm)

Model	A	B	C	D	E	F	G	H
15WUD	∅ 150	∅ 210	97	43	54	37.4	177	149
20WUD	∅ 200	∅ 271	98	36	62	36	237	201

## 26 Wall Mounted Ventilating Fans



15AAQ1



20AQM8 / 25AQM7 / 30AQM8

## Features



High efficiency for air flow and energy saving



Ball bearing motor for smooth rotation and excellent durability



Excellent for small room (Applicable to 15AAQ1)



Quiet operation



Automatic shutter

## Dimensions

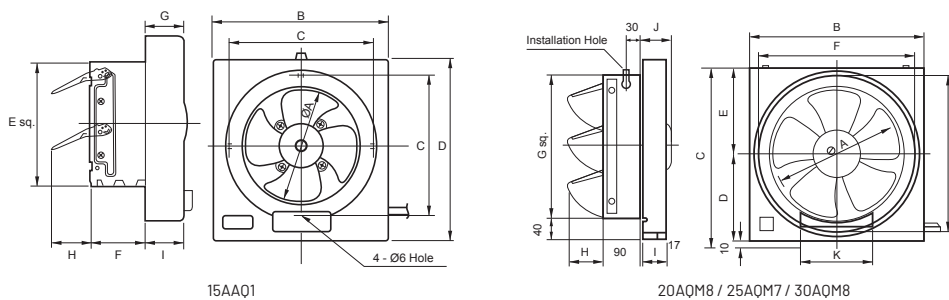

## Specifications

Model	Dimension	RPM	CFM	Motor Rating	Motor W	Motor HP	Motor Type	Noise Level (dB)	Nett Weight (kg)
15AAQ1	6"/15cm	1480	170	220-240V, 50Hz	15	-	Condenser	31	1.40
20AQM8	8"/20cm	1109-1301	318		14.9-18.3	0.02	4 Pole Condenser	37	2.30
25AQM7	10"/25cm	999-1221	530		25.2-30.8	0.03		39	2.60
30AQM8	12"/30cm	925-1085	727		31.8-38.8	0.05		45	3.00

## Dimension (mm)

Model	A	B	C	D	E	F	G	H	I	J	K
15AAQ1	150 dia.	240	195	254	170	75	55	54	52	-	-
20AQM8	200 dia.	300	310	160	150	260	240	83	45	68	140
25AQM7	250 dia.	350	360	185	175	310	290	65	40	48	150
30AQM8	300 dia.	400	410	210	200	360	340	81	40	48	160

## 27 Wall Mounted Ventilating Fans



20ALA / 25ALA

## Features



Advance aerodynamic blade design minimizes any obstacle against the airflow



Improved high performance condenser motor with long life bearing



Automatic shutter



Curve shape front louver design for better outlook and safety



Energy saving

## Dimensions

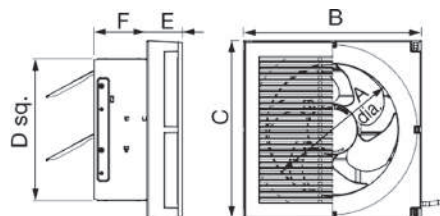

20ALA / 25ALA

## Specifications

Model	Dimension	RPM	CFM	Motor Rating	Motor W	Motor Type	Noise Level (dB)	Nett Weight (kg)
20ALA	8"/20cm	1280	323	220-240V, 50Hz	18	Condenser	38	2.00
25ALA	10"/25cm	1210	494		25		40.5	2.50

## Dimension (mm)

Model	A	B	C	D	E	F
20ALA	223	302	302	240	60	90
25ALA	273	352	352	290	62	90

## 28 Wall Mounted Ventilating Fans



10EGKB  
15EGKB

Accessories  
Included



Fan



Duct Sleeve



Duct Spinner



Pipe Hood

## Features



Easy cleaning



Energy saving



Exhaust moisture and odour, preventing mould



Excellent for bathroom use



Easy installation



Equipped with full accessories

## Dimensions

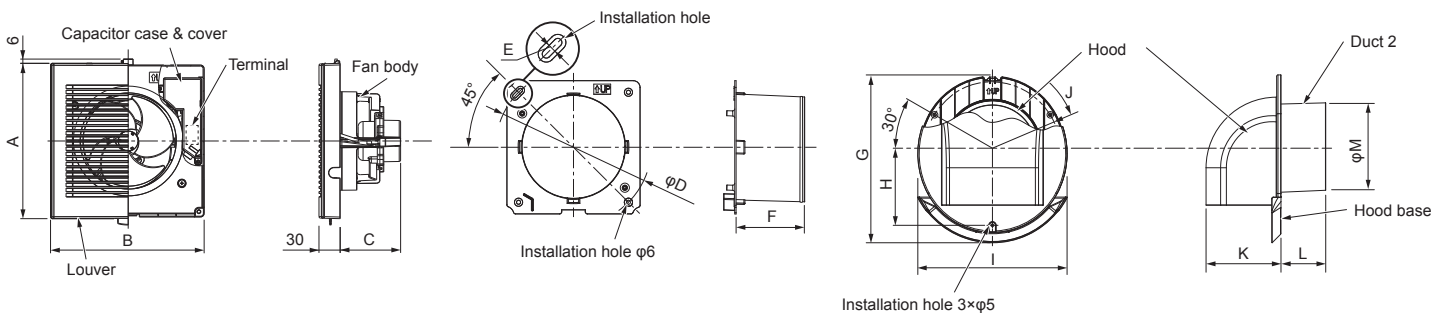

## Specifications

Model	Dimension	RPM	CFM	Motor Rating	Motor W	Noise Level (dB)	Nett Weight (kg)
10EGKB	4"/10cm	2690	45	220-240V, 50Hz	5.0	33	1.00
15EGKB	6"/15cm	2390	97		6.5	37	1.30

## Dimension (mm)

Model	A	B	C	D	E	F	G	H	I	J	K	L	M	Wall Installation	
														Hole Size (mm)	Wall Thickness (mm)
10EGKB	170	170	83	177	6	100	250	107	220	99	99	82	118	ø 130 ~ 140	100-150
15EGKB	220	220	86	231	6	100	310	142	270	123	138	82	161	ø 175 ~ 185	100-150

## 29 Ceiling Mounted Ventilating Fans



## Features



Q-Blade design for perfect balance and quiet operation



High efficiency for air flow and energy saving



Ball bearing motor for smoother and durable operation



Suitable for commercial and residential use

## Dimensions

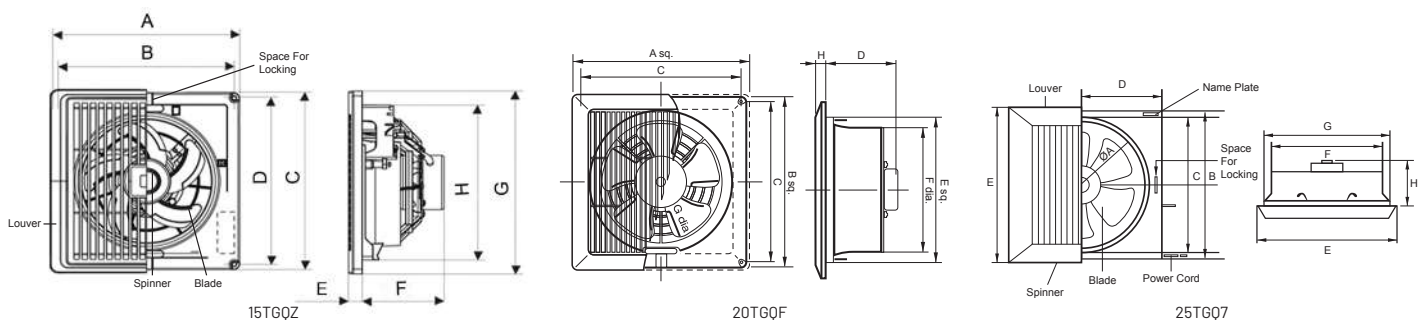

## Specifications

Model	Dimension	RPM	CFM	Motor Rating	Motor W	Motor HP	Motor Type	Noise Level (dB)	Nett Weight (kg)
15TG0Z	6"/15cm	1330	141	220-240V, 50Hz	12	-	Condenser	35	1.20
20TG0F	8"/20cm	1250	312		20	-	Condenser	41	1.30
25TG07	10"/25cm	959-1172	367		24.8-30.3	0.03	4 Pole Condenser	45	1.90

## Dimension (mm)

Model	A	B	C	D	E	F	G	H
15TG0Z	244	230	244	230	18	108	253	214
20TG0F	315	305	286	130	260	232	223	13
25TG07	250	355	336	177.5	365	272	310	117.5



# 30 Ceiling Mounted Sirocco Ventilating Fans



17CUH / 24CUH / 24CDH / 24CHH

## Features



Low noise with the distinctive design of Resonance-Noise-Absorption structure



Taper blade design to achieve strong and smooth ventilating performance



Optional duct cover (Refer page 36)



Better durability with well lubricated ball bearing type motor



Reverse flow prevention shutter (shutter deflection if slight, resulting in further improvement of air tightness)

## Dimensions

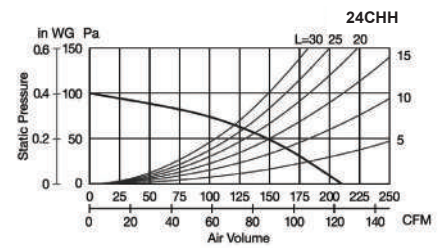
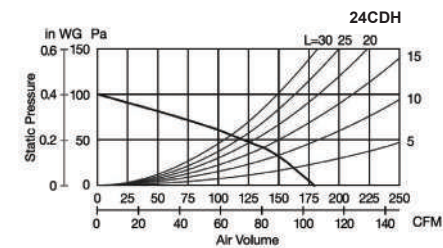
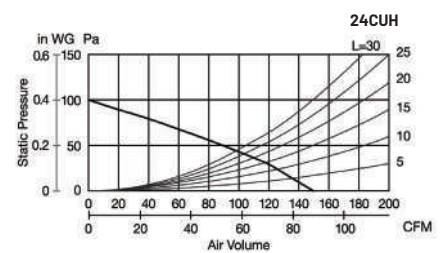
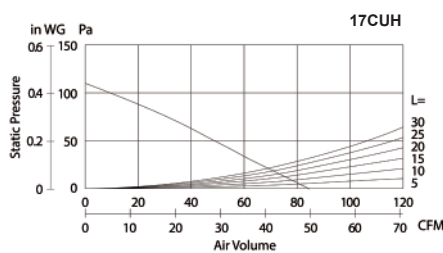
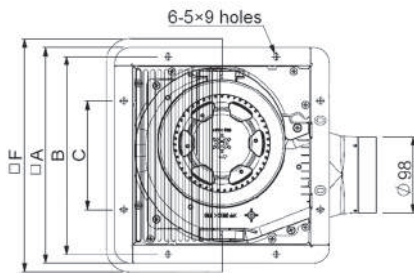

L : The length of duct (m) (The diameter of duct : Ø100mm)

## Specifications

Model	RPM	CFM	Motor Rating	Motor W	Noise Level (dB)	Nett Weight (kg)
17CUH	680	53		9.5	26	1.70
24CUH	530	94	220-240V, 50Hz	12.0	27	2.70
24CDH	790	106		15	30	2.70
24CHH	870	124		18	34	2.70

## Dimensions (mm)

Model	A	B	C	D	E	F	G	Applicable Pipe	Installation Space (mm)
17CUH	214	194	84	164	170	230	13	Ø 100	177 x 177
24CUH	278	255	140	175	233	300	13	Ø 100	240 x 240
24CDH	278	255	140	175	230	300	13	Ø 100	240 x 240
24CHH	278	255	140	175	230	300	13	Ø 100	240 x 240

# 31 Ceiling Mounted Sirocco Ventilating Fans



17CUBM / 24CUBM / 24CGBM

## Features



Stylish front louver design



Taper blade design to achieve strong and smooth ventilating performance



Optional duct cover (Refer page 36)



Better durability with well lubricated ball bearing type motor



Reverse flow prevention shutter (shutter deflection if slight, resulting in further improvement of air tightness)

## Dimensions

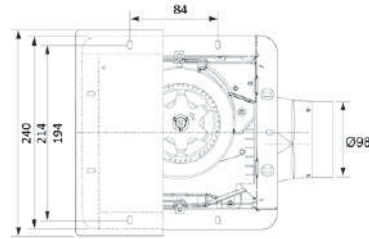
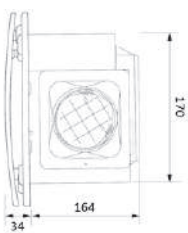

17CUBM

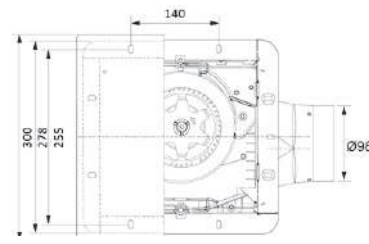
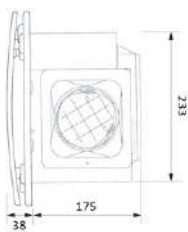
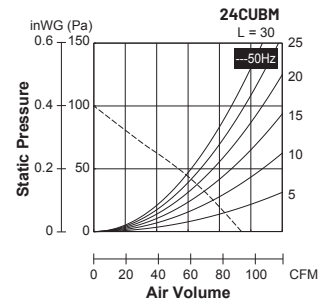
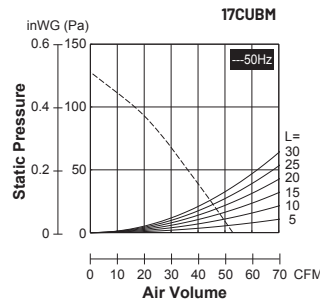

24CUBM / 24CGBM

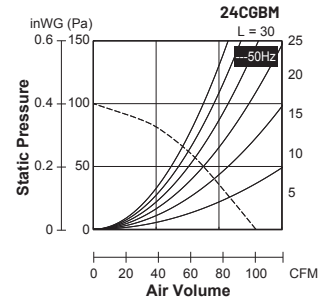

## Specifications

Model	RPM	CFM	Motor Rating	Motor W	Motor Type	Noise Level (dB)	Nett Weight (kg)
17CUBM	800	53	220-240V, 50Hz	9.5	2 Pole Condenser	24	1.90
24CUBM	680	94		12	4 Pole Condenser	26	2.90
24CGBM	995	129		25.5	4 Pole Condenser	38	2.90

## Dimensions (mm)

Model	A	B	C	D	E	F	G	Installation Space	Applicable Pipe
17CUBM	170	164	34	84	194	214	240	177 x 177	Ø 100
24CUBM	233	175	38	140	255	278	300	240 x 240	Ø 100
24CGBM	233	175	38	140	255	278	300	240 x 240	Ø 100



# 33 High Pressure Industrial Ventilating Fans



25GSC / 30GSC / 35GSC

## Features



The high-performance totally enclosed condenser motor contains a thermal protector which prevents the temperature of the motor from rising abnormally



A unique drain mechanism discourages the ingress of water and dust into the motor, resulting in excellent durability



Single Phase (Reversible)



Slimline design for optimum space utilization, permitting installation in equipment



Can be used over an ambient temperature range of -10°C to +50°C



Possible to install horizontally

## Dimensions

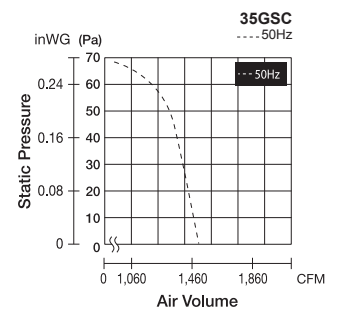
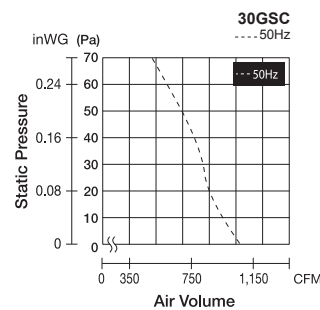
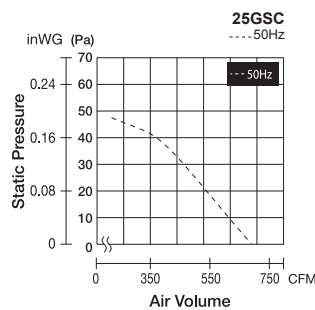
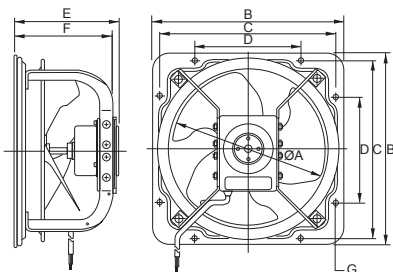

## Specifications

Model	Dimension	RPM	CFM	Motor Rating	Motor W	Motor Type	Noise Level (dB)	Nett Weight (kg)
<b>25GSC</b>	10"/25cm	1360	676	240V, 50Hz	39	4 Pole Induction	34	4.40
<b>30GSC</b>	12"/30cm	1360	1071		59		38	6.10
<b>35GSC</b>	14"/35cm	1420	1507		88		44	10.50

## Dimensions (mm)

Model	A	B	C	D	E	F	G
<b>25GSC</b>	250 dia.	327	298	165	171	164	10 dia.
<b>30GSC</b>	300 dia.	378	349	210	200	187	
<b>35GSC</b>	350 dia.	467	434	250	236	219	12 dia.

# 34 High Pressure Industrial Ventilating Fans



40GSC / 50GSC / 60GSC

## Features



The high-performance totally enclosed condenser motor contains a thermal protector which prevents the temperature of the motor from rising abnormally



A unique drain mechanism discourages the ingress of water and dust into the motor, resulting in excellent durability



Single Phase (Reversible)



Slimline design for optimum space utilization, permitting installation in equipment



Can be used over an ambient temperature range of -10°C to +50°C



Possible to install horizontally

## Dimensions

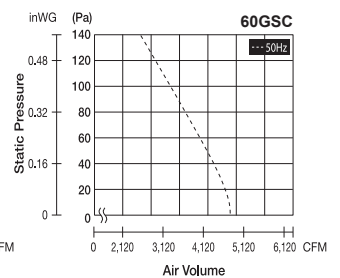
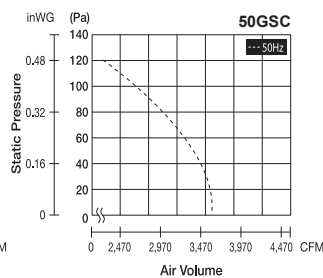
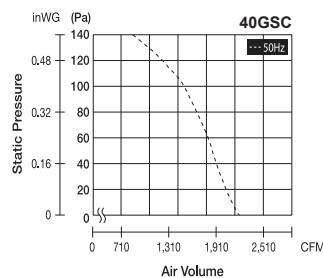
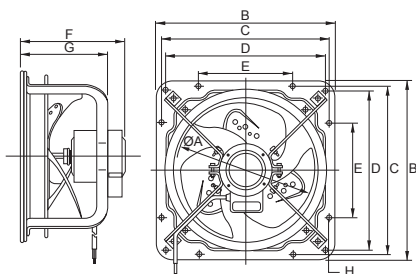

## Specifications

Model	Dimension	RPM	CFM	Motor Rating	Motor W	Motor Type	Noise Level (dB)	Nett Weight (kg)
40GSC	16"/40cm	1450	2125	240V, 50Hz	151	4 Pole Induction	47	19.00
50GSC	20"/50cm	960	3608		249	6 Pole Induction	47	22.50
60GSC	24"/60cm	970	4732		245		50	34.00

## Dimensions (mm)

Model	A	B	C	D	E	F	G	H
40GSC	400 dia.	518	485	460	280	274	225	12 dia.
50GSC	500 dia.	659	620	560	355	315	266	15 dia.
60GSC	620 dia.	720	720	650	400	320	262	

# 35 Industrial Ventilating Fans



40KAQA

## Features



To ventilate factories, warehouse, restaurant kitchen and other locations where powerful ventilation is necessary



Wave-shaped metal blade delivers abundant air volume



Powerful, efficient and durable condenser motor



Operate at an ambient temperature range of -10°C to +50°C



Durable powder coating for rust resistance



Equipped with automatic shutter

## Dimensions

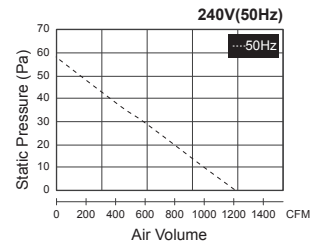
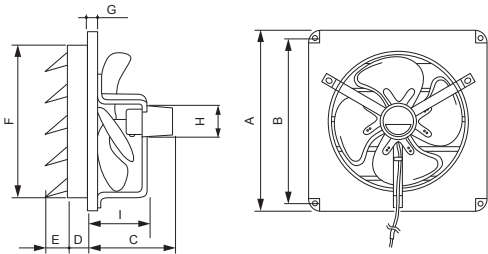

## Specifications

Model	Dimension	RPM	CFM	Motor Rating	Motor W	Motor Type	Noise Level (dB)	Nett Weight (kg)
40KAQA	16"/40cm	1410	1155	220-240V, 50Hz	66	4 Pole Condenser	51	6.40

## Dimensions (mm)

Model	A	B	C	D	E	F	G	H	I
40KAQA	510	480	215	40	55	434	10	126	130

## 36 Accessories

### Duct Cover For Ventilating Fan



MGX100K / MGX150K

## Features



High Strength  
- SUS 304  
stainless steel



Excellent anti-rust capability  
- hood part coated with  
metallic silver paint



Easy Installation  
- spring clips facilitate  
duct / pipe connection



Keep out ingress of  
small particles and  
insects from outside

## Dimensions

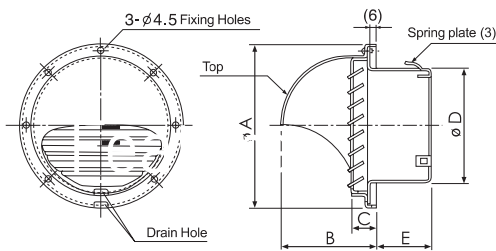

## Specifications

Model	A	B	C	D	E	Dimension of Net (mm)	Dimension of Applicable Pipe(mm)
<b>MGX100K</b>	141	79	20	97	48	2.5 x 2.5	100
<b>MGX150K</b>	190	106	23	147	53	2.5 x 2.5	150

**\* Applicable models**

100mm = 17CUH, 24CUH, 24CDH, 24CHH, 17CUBM, 24CUBM, 24CGBM  
150mm = 27CHH, 32CDH, 38CDG, 38CHG

### Extended Fan Rod for Ceiling Fan



Fan Rod

## Features



Equipped with full length safety wire  
with switch lever for safety switch



Available upon ordering  
(1-2 months lead time)



Available in  
various length

## Specifications

(Applicable to K12V0, K15V0, K15VC, K15W0-S)

Part Number	Description
<b>M15A002922MW</b>	Pipe Assy (30cm / 12")
<b>SPCF2001-M</b>	Pipe Assy (40cm / 16")
<b>SPCF2002-M</b>	Pipe Assy (45cm / 18")
<b>SPCF2003-M</b>	Pipe Assy (60cm / 24")
<b>SPCF2004-M</b>	Pipe Assy (75cm / 30")
<b>SPCF2005-M</b>	Pipe Assy (90cm / 36")
<b>SPCF2007-M</b>	Pipe Assy (120cm / 48")
<b>SPCF2008-M</b>	Pipe Assy (135cm / 54")
<b>SPCF2009-M</b>	Pipe Assy (150cm / 60")

(Applicable to K18NY-SBR Only)

Part Number	Description
<b>KZ30PB</b>	Pipe Assy (75cm / 30")
<b>KZ36PB</b>	Pipe Assy (90cm / 36")
<b>KZ48PB</b>	Pipe Assy (120cm / 48")
<b>KZ60PB</b>	Pipe Assy (150cm / 60")
<b>KZ79PB</b>	Pipe Assy (197.5cm / 79")

(Applicable to K14TE and K14QF Only)

Part Number	Description
<b>KZ30PEMK</b>	Pipe Assy - Dark Grey (75cm/ 30")
<b>KZ30PEMW</b>	Pipe Assy - White (75cm/ 30")
<b>KZ60PEMK</b>	Pipe Assy - Dark Grey (150cm/ 60")
<b>KZ60PEMW</b>	Pipe Assy - White (150cm/ 60")

(Applicable to K14XF Only)

Part Number	Description
<b>KZ24PFMH</b>	Pipe Assy - Grey (60cm / 24")
<b>KZ24PFMK</b>	Pipe Assy - Black (60cm / 24")
<b>KZ36PFMH</b>	Pipe Assy - Grey (90cm / 36")
<b>KZ36PFMK</b>	Pipe Assy - Black (90cm / 36")
<b>KZ48PFMH</b>	Pipe Assy - Grey (120cm / 48")
<b>KZ48PFMK</b>	Pipe Assy - Black (120cm / 48")
<b>KZ60PFMH</b>	Pipe Assy - Grey (150cm / 60")
<b>KZ60PFMK</b>	Pipe Assy - Black (150cm / 60")



---

Fans For Life!

---



SINCE 1909  
JAPAN

**KDK FANS (M) SDN BHD** (Company No: 200201001186/568849-X)  
3rd Floor, 15 Jalan Tandang, 46050 Petaling Jaya, Selangor.  
Tel : 03-7785 5011  
Fax : 03-7785 2655  
Website: [www.kdk.com.my](http://www.kdk.com.my)

Printed in Malaysia CATALOG NO : ME-24-B

07.22

Specifications are subject to change without prior notice  
\*\* Product may vary from pictures shown